

平鋼 最小曲げ半径

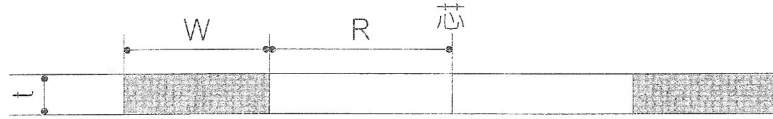

(フランジ曲げ)

t \ W	38	44	50	65	75	90	100	125	150	180	200	250	300
3	200	300	400										
4.5	170	170	200	450									
6	170	170	170	350	450	500	500	800	1000				
8	170	170	170	350	450	500	500	800	1000				
9	170	170	170	350	450	500	500	800	1000				
12	170	170	170	350	450	500	500	1000	1200	2000	2500		
16	170	170	250	400	450	500	600	1100	1200	2000	2500	2500	2500
19	170	170	250	500	500	500	600	1100	1200	2000	2500	2500	2500
22	200	200	300	500	500	500	700	1000	1500	2000	2500	2500	2500
25	200	200	300	500	500	500	700	1300	1500	2000	2500	2500	2500
28	200	200	300	500	500	500	700	2000	2000	2500	3000	3500	3500
32	250	250	300	500	500	500	700	2000	2000	2500	3000	3500	3500
36	300	300	400	500	500	500	700	2000	2000	3000	3000	3500	3500
44	400	400	500	500	500	500	700	2000	2000	3000	3000	3500	4000
50	400	400	500	500	500	500	1000	2000	2000	3000	3000	4000	4000

備考

- つかみ代 小型機 400mm (200mm x 2)
- 中型機 600mm (300mm x 2)
- 大型機 (A) 1000mm (500mm x 2)
- 大型機 (L) 1600mm (800mm x 2)
- 大型機 (LL) 1600mm (800mm x 2)

※ つかみ代についてはお問い合わせ下さい

※ 変形形状は別紙「変形および検査方法」をご覧ください。

等辺山形鋼 最小曲げ半径

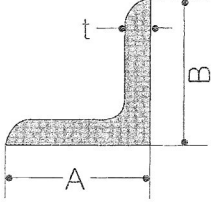
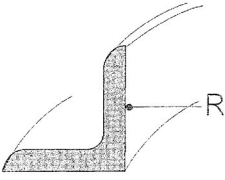
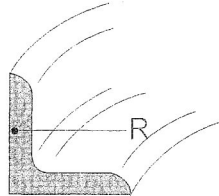
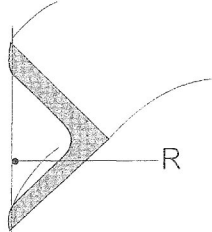
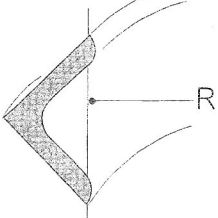
				
A x B x C	外 曲	内 曲	ソロバン外曲	ソロバン内曲
20 x 20 x 3	200	300	300	250
40 x 40 x 3	250	300	300	250
40 x 40 x 5	170	300	300	250
50 x 50 x 4	170	450	350	300
50 x 50 x 6	170	300	350	300
65 x 65 x 6	300	500	400	400
65 x 65 x 8	300	500	600	600
75 x 75 x 6	400	600	600	600
75 x 75 x 9	500	650	600	600
75 x 75 x 12	500	650	700	700
90 x 90 x 7	600	1200	700	700
100 x 100 x 7	600	1200		
100 x 100 x 10	600	1000		
100 x 100 x 13	600	1500		
130 x 130 x 9~15	1400	1500		
150 x 150 x 12	1500			
150 x 150 x 15	1500			
150 x 150 x 19				
200 x 200 x 15				
200 x 200 x 20				

備 考

※ つかみ代についてはお問い合わせ下さい

※ 変形形状は別紙「変形および検査方法」をご覧ください。

不等辺山形鋼 最小曲げ半径

A x B x C	外 曲	内 曲	外 曲	内 曲
90 x 75 x 9	500	800	600	1000
100 x 75 x 7~10	600	800	700	1000
100 x 75 x 13	800	800	1000	1000
125 x 75 x 7~13	800	1000	1000	1000
120 x 90 x 9~13	800	1000	1200	1200
150 x 90 x 9~12	900	1900	1200	1900
150 x 90 x 15	1000	1900	1200	
150 x 90 x 9~15	1000	1900		
備 考				

※ つかみ代についてはお問い合わせ下さい
 ※ 変形形状は別紙「変形および検査方法」をご覧ください。

溝形鋼 最小曲げ半径

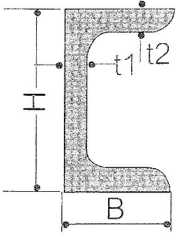
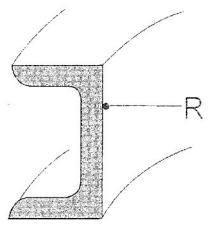
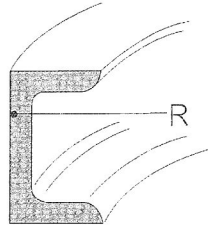
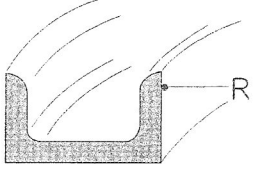
			
H x B x t1 x t2	外 曲	内 曲	フセ 曲
75 x 40 x 5.0 x 7.0	300	400	900
100 x 50 x 5.0 x 7.5	300	500	3000
125 x 65 x 6.0 x 8.0	500	700	5000
150 x 75 x 6.5 x 10.0	500	800	6000
150 x 75 x 9.0 x 12.5	500	800	6000
180 x 75 x 7.0 x 10.5	1000	1200	7000
200 x 70 x 7.0 x 10.0	1000	1200	7000
200 x 80 x 7.5 x 11.0	1200	1200	7000
200 x 90 x 8.0 x 13.5	1500	1200	8000
250 x 90 x 9.0 x 13.0	1500	1500	18000
250 x 90 x 11.0 x 14.5	1500	1500	18000
300 x 90 x 9.0 x 13.0	1800	2000	30000
300 x 90 x 10.0 x 15.5	1800	2000	30000
300 x 90 x 12.0 x 16.0	1800	2000	30000
380 x 100 x 10.5 x 16.0	2000	2500	30000
380 x 100 x 13.0 x 10.5	2000	2500	
380 x 100 x 13.0 x 20.0	2000	2500	

備 考

※ つかみ代についてはお問い合わせ下さい

※ 変形形状は別紙「変形および検査方法」をご覧ください。

I 形鋼 最小曲げ半径

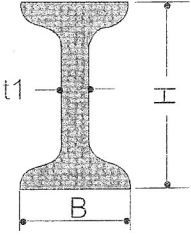
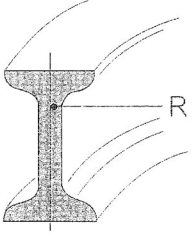
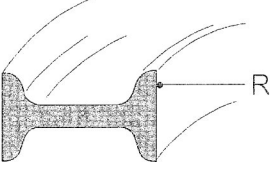
		
H x B x t1	モノレール曲	タテ曲
100 x 75 x 5.0 x 8.0	500	1000
125 x 75 x 5.5 x 9.5	300	1000
150 x 75 x 5.5 x 9.5	1000	2000
150 x 125 x 8.5 x 14.0	1000	2500
180 x 100 x 6.0 x 10.0	1000	2500
200 x 100 x 7.0 x 10.0	1000	5000
200 x 150 x 9.0 x 16.0	1000	5000
250 x 125 x 7.5 x 12.5	1200	6000
250 x 125 x 10.0 x 19.0	1200	6000
300 x 150 x 8.0 x 13.0	1500	7000
300 x 150 x 10.0 x 18.5	1500	7000
300 x 150 x 11.5 x 22.0	1500	7000
350 x 150 x 9.0 x 15.0	1500	8000
350 x 150 x 12.0 x 24.0	1500	8000
400 x 150 x 10.0 x 18.0	1500	10000
400 x 150 x 12.5 x 25.0	1500	10000
450 x 175 x 11.0 x 20.0	1900	12000
600 x 190 x 16.0 x 35.0	1900	15000

備考

※ つかみ代についてはお問い合わせ下さい

※ 変形形状は別紙「変形および検査方法」をご覧ください。

H形鋼 最小曲げ半径（広幅・中幅）

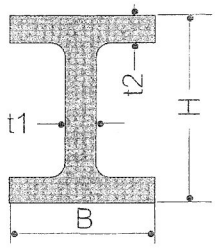
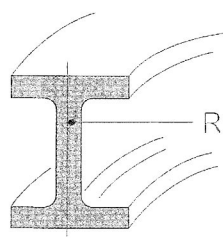
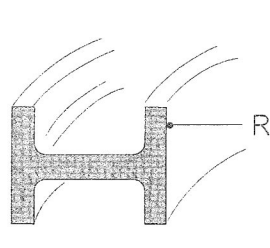
系列			
	H x B x t1 x t2	モノレール曲	タテ曲
広幅	100 x 100 x 6.0 x 8.0	500	1200
	125 x 125 x 6.5 x 9.0	800	1800
	150 x 150 x 7.0 x 11.0	1000	1800
	175 x 175 x 7.5 x 11.0	1000	3500
	200 x 200 x 8.0 x 12.0	1800	4000
	250 x 250 x 9.0 x 14.0	2500	5000
	300 x 300 x 10.0 x 15.0	3000	7500
	350 x 350 x 12.0 x 19.0	4000	9000
	400 x 400 x 13.0 x 21.0	5000	14000
中幅	148 x 100 x 6.0 x 9.0	500	1500
	194 x 150 x 6.0 x 9.0	1000	3500
	244 x 175 x 7.0 x 11.0	1200	5500
	294 x 200 x 8.0 x 12.0	1800	6000
	340 x 250 x 9.0 x 14.0	2500	9000
	390 x 300 x 10.0 x 16.0	3000	9000
	440 x 300 x 11.0 x 18.0	3000	13000
	488 x 300 x 11.0 x 18.0	3000	14000
	588 x 300 x 12.0 x 20.0	3500	15000
	700 x 300 x 13.0 x 24.0	4000	34000
800 x 300 x 14.0 x 26.0	5000	34000	
備考			
<p>※ タテ曲については形状等、担当者にお問い合わせ下さい</p> <p>※ つかみ代についてはお問い合わせ下さい</p> <p>※ 変形形状は別紙「変形および検査方法」をご覧ください。</p>			

H形鋼 最小曲げ半径（細幅）

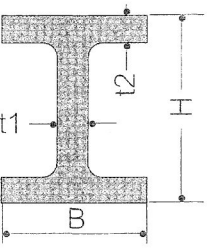
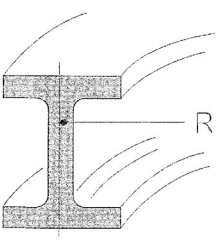
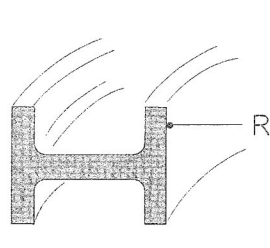
系列			
	H x B x t1 x t2	モノレール曲	タテ曲
細幅	100 x 50 x 5.0 x 7.0	350	1000
	125 x 60 x 6.0 x 8.0	400	1500
	150 x 75 x 5.0 x 7.0	450	1300
	175 x 90 x 5.0 x 8.0	600	1700
	200 x 100 x 5.5 x 8.0	300	1800
	250 x 125 x 6.0 x 9.0	1200	3500
	300 x 150 x 6.5 x 9.0	1000	6000
	350 x 175 x 7.0 x 11.0	1500	6000
	400 x 200 x 8.0 x 13.0	1800	7500
	450 x 200 x 8.0 x 13.0	1800	10000
	500 x 200 x 10.0 x 16.0	2000	8500
	600 x 200 x 11.0 x 17.0	2500	15000
備考			
<p>※ タテ曲については形状等、担当者にお問い合わせ下さい</p> <p>※ つかみ代についてはお問い合わせ下さい</p> <p>※ 変形形状は別紙「変形および検査方法」をご覧ください。</p>			

C T形鋼 最小曲げ半径

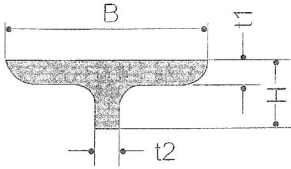
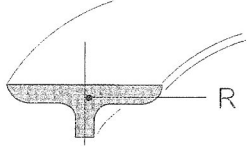
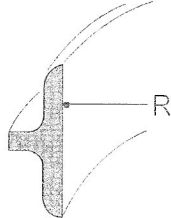
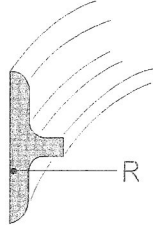
			
H x B x t1 x t2	フランジ曲	外 曲	内 曲
50 x 50 x 5.0 x 7.0	300	300	350
50 x 100 x 6.0 x 8.0	500	500	550
62.5 x 60 x 6.0 x 8.0	300	300	400
62.5 x 125 x 6.5 x 9.0	500	500	600
75 x 75 x 5.0 x 7.0	400	400	500
74 x 100 x 6.0 x 9.0	500	500	600
75 x 150 x 7.0 x 10.0	1500	500	600
87.5 x 90 x 5.0 x 8.0	500	500	600
87.5 x 175 x 7.5 x 11.0	1500	500	600
100 x 100 x 5.5 x 8.0	500	500	600
97 x 150 x 6.0 x 9.0	1500	500	600
100 x 200 x 8.0 x 12.0	2000	1000	1200
125 x 125 x 6.0 x 9.0	1500	1000	1200
122 x 175 x 7.0 x 11.0	1500	1000	1700
125 x 250 x 9.0 x 14.0	2500	1000	1700
150 x 150 x 6.5~9.0	1500	1200	1700
147 x 200 x 8.0 x 12.0	2500	1500	1700
150 x 150 x 10.0 x 15.0	1500	1200	1700
175 x 175 x 7.0 x 11.0	1500	1500	2000
170 x 250 x 9.0 x 14.0	3000	1500	2000
175 x 350 x 12.0 x 19.0		2000	2000

備 考

※ つかみ代についてはお問い合わせ下さい

※ 変形形状は別紙「変形および検査方法」をご覧ください。

レール 最小曲げ半径

				
	レール曲	外 曲	内 曲	
15kgレール	1000	1000	1000	
22kgレール	1000	1000	1000	
30kgレール	1500	1800	1800	
37kgレール	1500	1800	1800	
40kgレール	1800	2000	2000	
50kgレール	2000	2200	2200	
73kgレール	3500	5000	5000	
100kgレール	5000	8000	8000	

備 考

- ※ 15kg~50kgレールは最小限R以下でも御相談下さい
- ※ つかみ代についてはお問い合わせ下さい
- ※ 変形形状は別紙「変形および検査方法」をご覧ください。

パイプ 最小曲げ半径

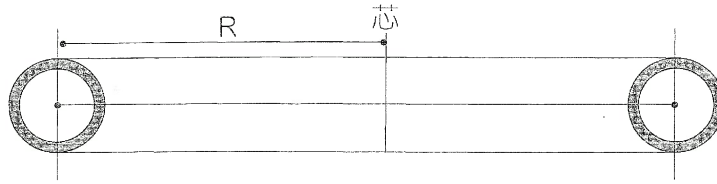

呼び径		外径	(上段) 厚さ t (下段) 曲半径 R															
A	B		t	R	t	R	t	R	t	R	t	R						
6	1/8	10.5	t	1.7	2	2.2	2.4											
			R	165	165		165											
8	1/4	13.8	t	2.2	2.3	2.4	3.0											
			R	170	170													
10	3/8	17.3	t	2.3	2.8	3.2												
			R	180		180												
15	1/2	21.7	t	1.9	2.8	3.2	3.7											
			R		180		180											
20	3/4	27.2	t	1.9	2.3	2.8	2.9	3.4	3.9									
			R			180	180		180									
25	1	34.0	t	2.3	3.2	3.4	3.9	4.5										
			R		180	180		180										
32	1 1/4	42.7	t	2.3	2.4	3.2	3.5	3.6	4.5	4.9								
			R				250	250		200								
40	1 1/2	48.6	t	2.3	2.4	3.2	3.5	3.7	4.5	5.1								
			R				250	250		200								
50	2	60.5	t	2.3	2.8	3.2	3.8	3.9	4.9	5.5								
			R				300	300		300								
65	2 1/2	76.3	t	2.8	3.2	4.2	4.5	5.2	6.0	7.0								
			R			450		450		450								
80	3	89.1	t	2.3	2.8	3.2	3.5	4.2	4.5	5.5	6.6	7.6						
			R					450		450		450						
90	3 1/2	101.6	t	3.2	3.5	4.2	4.5	5.7	7.0	8.1								
			R			550		550		550								
100	4	114.3	t	2.8	3.5	4.5	4.9	6.0	7.1	8.6								
			R			600		600		600								
125	5	139.8	t	3.5	4.0	4.5	5.0	5.1	6.6	8.1	9.5							
			R			1200			1200		1200							
150	6	165.2	t	3.8	4.0	4.5	5.0	5.5	7.1	9.3	11.0							
			R				1500		1500		1500							
175	7	190.7	t	5.3														
			R	1500														
200	8	216.3	t	4.5	5.8	6.4	7.0	8.2	10.3	12.7								
			R		2000				3000	6000								
250	10	267.4	t	6.0	6.4	6.6	7.8	9.3	12.7	15.1								
			R			8000		6000		10000								
300	12	318.5	t	6.0	6.4	6.9	7.9	8.4	10.3	14.3	17.4							
			R			10000			6500		20000							
350	14	355.6	t	6.4	7.9	9.5	11.1	14.3	19.0	23.8								
			R		15000		7000											

※ 備考

※ 扁平により使用される許容があると思いますので担当者にお問い合わせ下さい

リップみぞ形鋼 最小曲げ半径

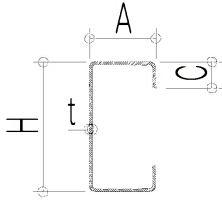
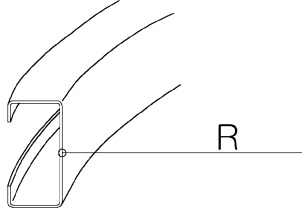
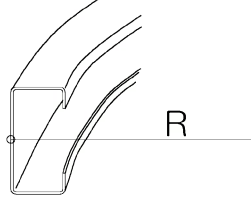
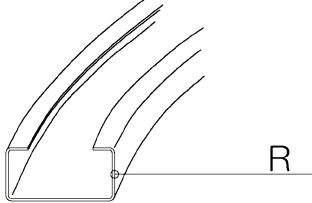
			
H x A x C x t	外 曲	内 曲	フセ曲
75 x 45 x 15 x 2.3	1500		3500
100 x 50 x 20 x 2.3	1300	1600	
100 x 50 x 20 x 3.2			
125 x 50 x 20 x 2.3	6000		
125 x 50 x 20 x 3.2			
150 x 50 x 20 x 2.3			
150 x 50 x 20 x 3.2	15000	7000	125000
150 x 75 x 20 x 2.3			
150 x 75 x 20 x 3.2	5000		98000

備 考

- ※ 上記Rの変形形状については必ずお問い合わせ下さい（シワ・ヘコミ・波がある為）
- ※ 本表は弊社実績加工分を記載しています
- ※ つかみ代についてはお問い合わせ下さい
- ※ 変形形状は別紙「変形および検査方法」をご覧ください。

角パイプ 最小曲げ半径

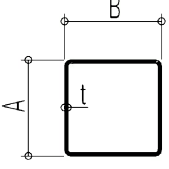
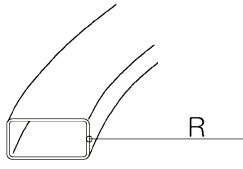
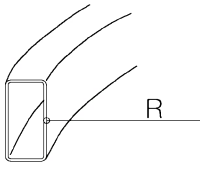
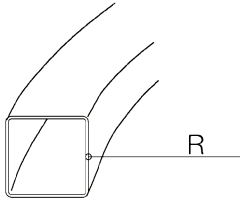
			
A x B x t	フセ曲	ベタ曲	平曲
50 x 50 x 2.3			
60 x 60 x 2.3			2100
75 x 75 x 4.5			1500
100 x 100 x 2.3			3000
100 x 100 x 3.2			2500
125 x 125 x 3.2			8000
125 x 125 x 4.5			5000
150 x 150 x 6.0			33000
200 x 200 x 6.0			
200 x 200 x 9.0			10000
250 x 250 x 9.0			16000
60 x 30 x 2.3	1500		
100 x 50 x 2.3	1700	1000	
100 x 50 x 3.2	1300		
125 x 75 x 3.2	4000		
150 x 75 x 3.2	10000		
150 x 100 x 4.5		3000	
200 x 100 x 6.0		2000	

備考

- ※ 上記Rの変形形状については必ずお問い合わせ下さい（シワ・ヘコミ・波がある為）
- ※ 本表は弊社実績加工分を記載しています
- ※ つかみ代についてはお問い合わせ下さい
- ※ 変形形状は別紙「変形および検査方法」をご覧ください。

変形状

■等辺山型鋼

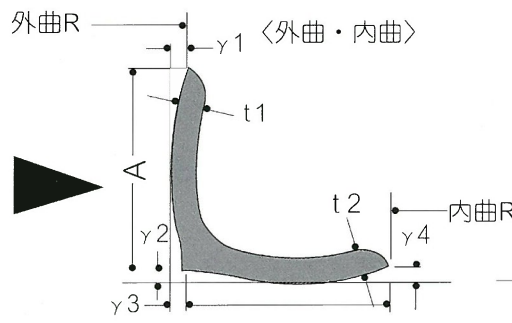
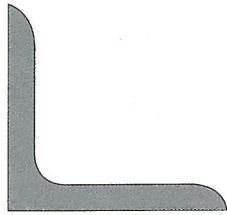

■平鋼 〈フランジ曲〉

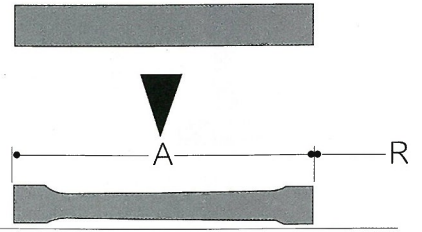

■H型鋼

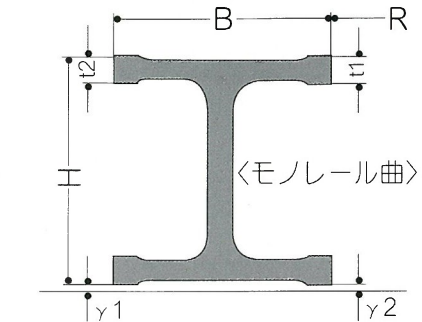
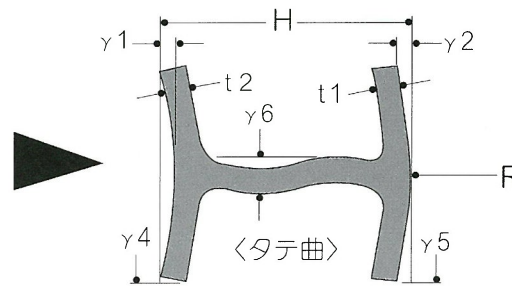
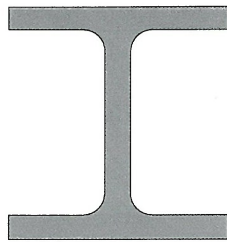

■溝型鋼

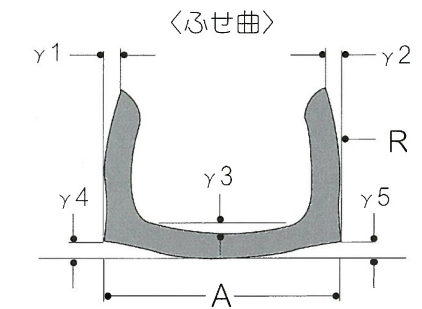
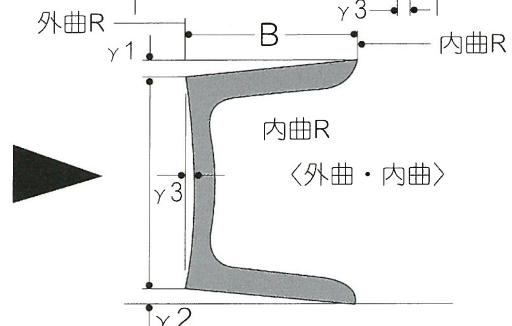
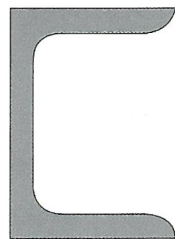

■パイプ

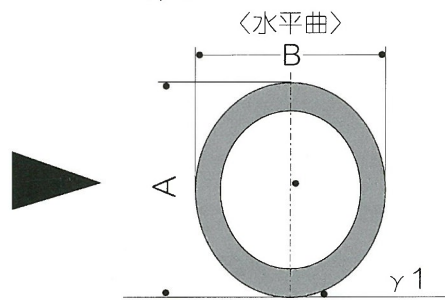
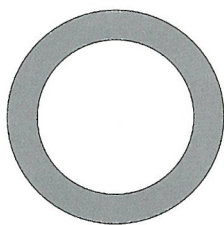

■R計測 (弧の高さ)

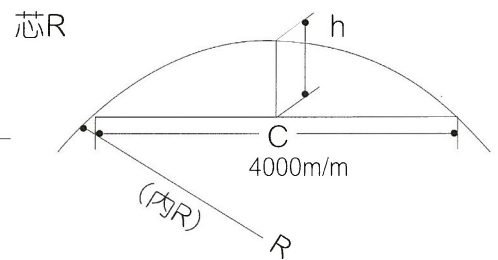

パイプベンダ (R金型・芯金)

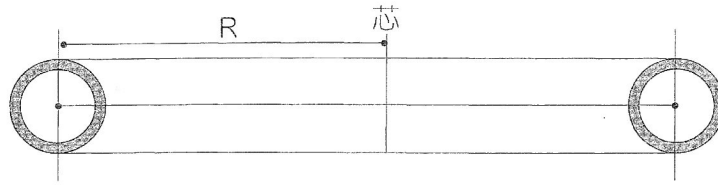

呼び径		外径	< R金型 >							< 芯金 >						
A	B															
10	3/8	17.3		50												
15	1/2	21.7	40	50	60						1.9	2.8	3.7			
20	3/4	27.2	40	50	55	60	75	100	120		1.9	2.3	2.8	3	3.9	
25	1	34.0	50	60	70	75	100	120	150		2.0	2.3	3.0	3.2	3.5	4.5
32	1 1/4	42.7	70	100	120	150					2.3	3.5	4.9			
40	1 1/2	48.6	90	100	120	125	150				3.0	3.5	3.7	5.1		
50	2	60.5	100	150							3.9	5.5				

その他Rについてはお問い合わせ下さい